

Delivering leading edge, innovative power solutions for more than 30 years....

Model:GTM96600-65VV-P2(SR with fixed Plug 2 pin)

May 26, 2022

GTM96600-65VV-P2(SR with fixed Plug 2 pin)

Information

Model Number

GTM96600-65VV-P2(SR with fixed Plug 2 pin)

Description

GTM96600-65VV-P2(SR with fixed Plug 2 pin), ICT / ITE / Medical Power Supply/Class 2/Household Power Supply, 60601-1-4th Ed. , Potted/Encapsulated in plastic housing, Regulated Switchmode AC-DC Power Supply AC Adaptor, , Input Rating: 100-240V~, 50-60 Hz, See "Blade/Cord Installed" section. Contact GlobTek for customization requests such as Molded country plugs, Molex or TE connectors, or IEC connectors mounted on any type of cable in any customer specified lengths., Output Rating: 60 Watts, Power rating with convection cooling (W) , 5-48V in 0.1V increments, Approvals: CB 60950; CB 62368; CE; China RoHS; Double Insulation; EAC; cETLus 60601-1; IP68; PSE; PSE; PSE; Level VI; LPS 60950; RCM; Ukraine; VCCI; WEEE; cETLus UL1310 (36V only); UKCA; S-Mark IEC/EN 60601-1; CB 61158; Morocco; GEMS (5V) pending; RCM 5V (pending);Korea (5V Only);

Model Picture



Agency Documents

<http://www.globtek.info/certs/GTM96600-TZ/>

CE EC-Declaration

https://www.globtek.com/pdf/ec_declaration/a000c00000Q0hRKEAZ

RoHS/RoHS2 Declaration

https://www.globtek.com/pdf/rohs_cert/a000c00000Q0hRKEAZ

REACH Declaration

https://www.globtek.com/pdf/iso_certificates/REACH.pdf

Conflict Minerals Declaration

<https://www.globtek.com/pdf/conflict-minerals.pdf>

Delivering leading edge, innovative power solutions for more than **30** years....

Model:GTM96600-65VV-P2(SR with fixed Plug 2 pin)

May 26, 2022

MODEL PARAMETERS

Type	Potted/Encapsulated in plastic housing
Technology	Regulated Switchmode AC-DC Power Supply AC Adaptor
Category	ICT / ITE / Medical Power Supply/Class 2/Household Power Supply
Input Voltage	100-240V~, 50-60 Hz
I/P Amps (A)	1.5A
Wattage (W)	60.0
Vout Range (V)	5-48
Efficiency Level	USA DOE Level VI / Eco-design Directive 2009/125/EC, (EU) 2019/1782
Ingress Protection	IP68
Size (mm)	114.81*57.11*39.0

Delivering leading edge, innovative power solutions for more than 30 years....

Model:GTM96600-65VV-P2(SR with fixed Plug 2 pin)

May 26, 2022

ENCLOSURE

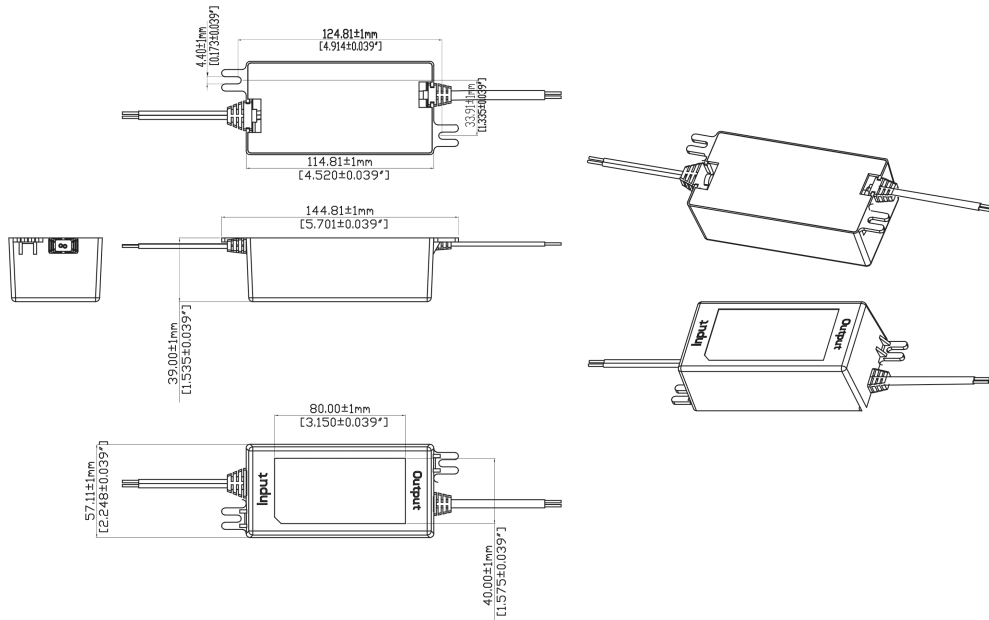
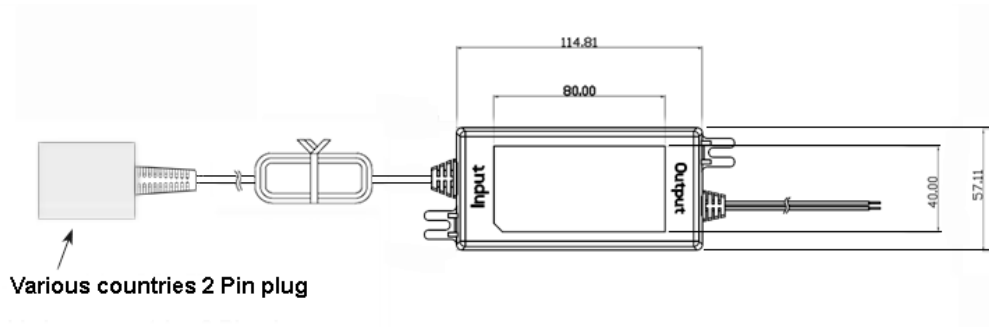

Delivering leading edge, innovative power solutions for more than **30** years....

Model:GTM96600-65VV-P2(SR with fixed Plug 2 pin)

May 26, 2022

RATING TABLE

Model Number	Voltage	Amps(A)	Watts(W)	RFQ
--------------	---------	---------	----------	-----

Model:GTM96600-65VV-P2(SR with fixed Plug 2 pin)

May 26, 2022

SPECIFICATIONS

A) ELECTRICAL SPECIFICATIONS:

01. Input Voltage: Specified 90-264 Vac, Nameplate rated: 100-240Vac
 - 90-264 Vac range @ 100% of rated load current
 - 85-264 Vac range @ 85% of rated load current
 - 110-370 VDC range @ 100% of rated load current
02. Input Frequency: Specified 47-63 Hz, Nameplate rated 50-60Hz
03. Output Regulation: +/- 5% measured at the output connector
04. Line Voltage Regulation: +/- 0.5% typical measured at full load
05. Green Power On Indicator LED
06. Output Ripple (Vp-p): 1% or 100 mV whichever is greater, measured at 20 MHz bandwidth with 0.1 uf ceramic capacitor in parallel with a low impedance 47 uf electrolytic capacitor connected at the end of the output connector
07. Turn-ON/OFF Overshoot: 5% maximum, 1 mS typical recovery time for 40% to 70% step load
08. Turn-ON Delay: 1 second maximum @ full load, nominal line
09. Hold-Up Time: 8 mS typical @ nominal input voltage and full load
10. Inrush Current: 30A/60A maximum cold start @ 115/230Vac input
11. Efficiency: Compliant with Efficiency Level VI and CoC Tier 2 standards
12. No Load Standby Power: <0.075 W @ 230Vac for <= 49W output power rating,
<0.15W @ 230Vac for > 49W output power rating

B) PROTECTION

01. Input Protection: Input line fusing and 300Vac MOV
02. Short Circuit/ Overload: Electronically Protected unit will auto recover upon removal of fault
 - Output Current Limit: 110% to 160% of rated output current
 - (upper end of current limit range is determined by normal output power rating, not derated output power level)
03. Output Over-Voltage: 110% to 130% of nominal output voltage

C) SAFETY

01. Dielectric Withstand Voltage: 4000Vac or 5656Vdc from input to output, On Class I models, 3000Vac or 4242Vdc from input to earth
02. Earth Leakage Current: Class I models < 300uA, N/A for Class II models
03. Touch Current: Class I models < 20uA, Class II models < 85uA, F2 Models < 20uA
04. Output Isolation Options:
 - a) C8 or C18 Inlet, Class II
 - b) C6 or C14 Inlet, Class II FE, Output Isolated from Earth contact
 - c) C6 or C14 Inlet, Class I, Output negative directly attached to Earth contact
05. Earth Continuity Test: < 0.1 Ohm between Earth Pin at AC input and PCB termination point (Class I models only)
06. Means of Protection: 2 x MOPP
07. Compliant Standards: See listings at end of this drawing for specifics

D) EMC

- EN 60601-1-2, 4th edition
Emissions, per EN 55032, EN 61000-6-3, EN 61000-6-4
Conducted Emissions: Class B, FCC Part 15, Class B
Radiated Emissions: Class B, FCC Part 15, Class B

PROPRIETARY INFORMATION

PROPRIETARY OF GLOBTEK, INC. ANY REPRODUCTION, DISCLOSURE OR USE OF THIS DRAWING, IN WHOLE OR IN PART, IS HEREBY PROHIBITED EXCEPT AS SPECIFIED IN WRITING BY GLOBTEK, INC.

<https://www.globtek.com/datasheet/w70384>

Delivering leading edge, innovative power solutions for more than 30 years....

Model:GTM96600-65VV-P2(SR with fixed Plug 2 pin)

May 26, 2022

Line Frequency Harmonics EN61000-3-2, Class A
Voltage Fluctuations/Flicker EN61000-3-3

Immunity, per EN 55024, EN 61000-6-1, EN 61000-6-2
Static Discharge Immunity EN61000-4-2, 10kV Contact Discharge, 20kV air discharge
Radiated RF Immunity EN61000-4-3, 10V/m 80-1000MHz, 3V/m 1-2.7GHz, 80% 1KHz AM.
EFT/Burst Immunity EN61000-4-4, 4kV/100kHz.
Line Surge Immunity EN61000-4-5, 2kV differential, 4kV common-mode
Conducted RF Immunity EN61000-4-6, 3Vrms, 80% 1KHz AM
Power Frequency Magnetic Field Immunity EN61000-4-8, 3A/m
Voltage Dip Immunity EN61000-4-11, Criteria

E) OTHER:

01. MTBF: 1,000,000 Hours @ 40°C ambient temperature, Full Load
02. GTM96600 Family: -20°C to 40°C ambient temperature with full load
Regarding Operating Temperature,
 - a- See below derating table for output power capability at alternate temperature
 - b- Extended low end temperature range available as custom option
03. Operating Humidity: 0% to 95% relative humidity, non-condensing
04. Storage Temperature: -30°C to 80°C
05. Operating Altitude: 5000 Meters
06. Ingress Protection: IP40 standard, IP52 available as special option
07. ROHS: Compliant with latest regulations, see approvals section below

F) ENCLOSURE

01. Housing: High impact plastic, 94V0 polycarbonate, non-vented
02. Markings: Label or Laser Printed
03. AC Input mechanical options: Desktop C6, C8, C14 or C18 IEC Inlet.
Hybrid option (Desktop or Changeable Blade Wall Plug-in) Class I or Class II input

G) SPECIAL OPTIONS

01. Cost reduction, removal of LED
02. Custom Cordsets, various cordage types, and connector types
03. Custom Markings
04. Short term Output Surge Capability
05. Reduced Leakage Current versions
06. Tightened output voltage tolerance
07. Reduced output ripple level
08. Reduced output power rating marking
09. High Rel PCB laminate with Plated through Holes for IPC610 Class 2 Compliance
10. Low Temperature operation, down to -40°C
11. Special Housing Colors and Cordset Colors

H) OUTPUT CONNECTORS

Several output connector options are available with various output current ratings.
GlobTek can supply 10A rated 2.1mm and 2.5mm style DC Power Jacks, to complement our
10A output rated 2.1mm and 2.5mm DC power plugs used on our output cordsets.
Please visit <https://en.globtek.com/news/high-current-coaxial-barrel-plug-jacks-for-high-wattage-power-supplies> for a real time product

PROPRIETARY INFORMATION

PROPRIETARY OF GLOBTEK, INC. ANY REPRODUCTION, DISCLOSURE OR USE OF THIS DRAWING, IN WHOLE OR IN PART, IS HEREBY PROHIBITED
EXCEPT AS SPECIFIED IN WRITING BY GLOBTEK, INC.

<https://www.globtek.com/datasheet/w70384>

Delivering leading edge, innovative power solutions for more than **30** years....

Model:GTM96600-65VV-P2(SR with fixed Plug 2 pin)

May 26, 2022

offering of mating connectors.

Delivering leading edge, innovative power solutions for more than 30 years....

Model:GTM96600-65VV-P2(SR with fixed Plug 2 pin)

May 26, 2022

DERATING CURVE

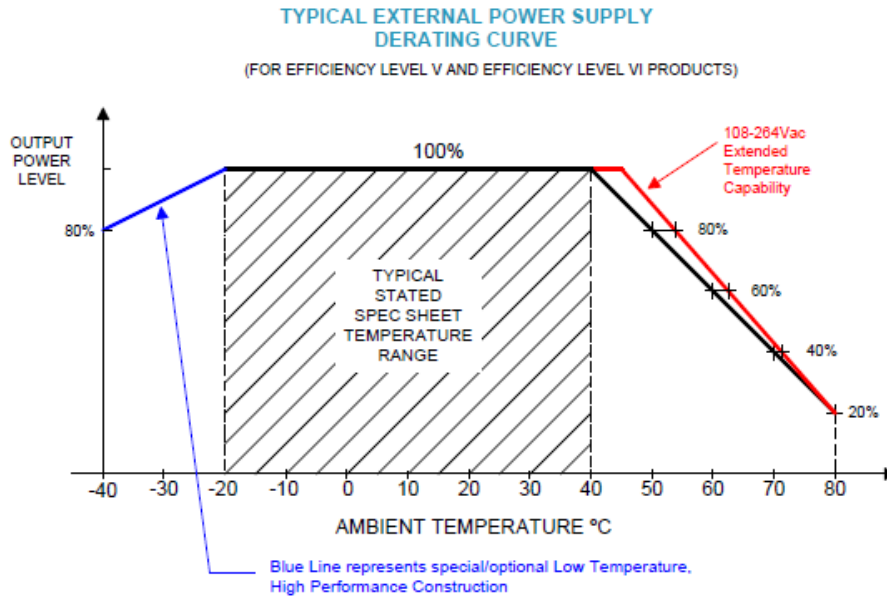

Delivering leading edge, innovative power solutions for more than **30** years....

Model:GTM96600-65VV-P2(SR with fixed Plug 2 pin)

May 26, 2022

INPUT CONFIGURATIONDescription

See "Blade/Cord Installed" section. Contact GlobTek for customization requests such as Molded country plugs, Molex or TE connectors, or IEC connectors mounted on any type of cable in any customer specified lengths.

Delivering leading edge, innovative power solutions for more than 30 years....

Model:GTM96600-65VV-P2(SR with fixed Plug 2 pin)

May 26, 2022

OUTPUT CONFIGURATION

Common output connector options:

 L Type (Coaxial
5.5x2.5mm plug)

 C Type (Coaxial
5.5x2.1mm plug)

 K Type (Coaxial
3.5x1.3mm plug)

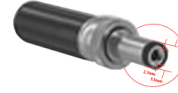
 LL Type (5.5x2.5mm
Locking 760k type)

 CL Type (5.5x2.1mm
Locking S761k type)

 ML2 Type (Molex
housing 43025-0200)

 YL3 Type
(KPPX-3P)

YL4 Type (KPPX-4P)

 EJ1/2/3/4/5 (EIAJ
RC-5320A type
connectors)

 MSB Type (Micro
USB)

 USBC Type (USB
Type C)

 Inquire for custom
design

 For a comprehensive list of options, [click here](#)







Contact GlobTek for your specific requirements or custom solutions.

Delivering leading edge, innovative power solutions for more than 30 years....

Model:GTM96600-65VV-P2(SR with fixed Plug 2 pin)

May 26, 2022









Approvals

Logo	Description
No Logo Applicable	CB for IEC 60950-1:2005+A1+A2
No Logo Applicable	IEC 61558-1:2005+A1, IEC 61558-2-16:2009+A1
No Logo Applicable	CB for IEC 62368-1:2014 (Second Edition)
	Test standard: EN 55032:2012+AC:2013 EN 61000-3-2:2014 EN 61000-3-3:2013 EN 55024:2010 EN 60601-1-2:2015
	Conforms to UL Std. 1310 CLASS 2 Power Units Cert. to CSA Std. C22.2 NO. 223 (36 volts only)
	CHINA SJ/T 11364-2014, China RoHS Chart: http://en.globtek.com/globtek-rohs.php
	
	Declaration ДС № EAЭC N RU Д-US.KA01.B.10453_19 Custom Union of Russia, Belarus and Kazakhstan http://www.globtek.com/redirect/?loc=gost-certificate-eac-declaration
No Logo	Greenhouse and Energy Minimum Standards (GEMS) for model GTM96600-2305-P2 (pending)
	Medical Electrical Equipment - Part 1: General Requirements For Basic Safety And Essential Performance [AAMI ES60601-1:2005 +A1]

Delivering leading edge, innovative power solutions for more than 30 years....

Model:GTM96600-65VV-P2(SR with fixed Plug 2 pin)





May 26, 2022

	Indoor Use Only - Mark is on the label or Molded in the case
IP68	Ingress Protection: ?IP68 to IEC60529:2001 Totally dust tight and Protected against long periods of immersion under pressure
 GlobTek, Inc.	JAPAN TUV R-PSE, Cert. No. JD 50313287, to J60950-1(H26) , J55022(H22),J3000(H25)[DC15?30V]. Please reference the following website for guidelines on PSE regulations: http://en.globtek.com/importing-ite-and-medical-power-supplies-ac-adaptors-to-japan/
 GlobTek, Inc.	JAPAN TUV R-PSE, Cert. No. JD 50313287, to J60950-1(H26) , J55022(H22),J3000(H25)[DC30?60V]. Please reference the following website for guidelines on PSE regulations: http://en.globtek.com/importing-ite-and-medical-power-supplies-ac-adaptors-to-japan/
 GlobTek, Inc.	JAPAN TUV R-PSE, Cert. No. JD 50469658, to J62368-1(H30) , J55032(H29),J3000(H25)[15V or less]. Please reference the following website for guidelines on PSE regulations: http://en.globtek.com/importing-ite-and-medical-power-supplies-ac-adaptors-to-japan/
	Korea for GTM96600-2305-P2 (5V)
EFFICIENCY LEVEL 	Efficiency: complies to section 301 of Energy Independence and Security Act (EISA) complies with Energy Star tier 2 (North America), ECP tier 2 (China), MEPS tier 2 (Australia), Code of Conduct (Europe)
LPS	Limited Power Source 60950
	Morocco SDoC declaration http://www.globtek.info/certs/Morocco%20SDoC%20Declaration/
	RCM certificate ; Australia and New Zealand Regulatory Compliance, Mark (http://rcm.standards.org.au/rcmfaq/rcmfaq.htm
No Logo	Australia and New Zealand Regulatory Compliance, Mark (http://rcm.standards.org.au/rcmfaq/rcmfaq.htm (pending)
 Intertek	S-Mark Certificate EN 60601-1:2006+A1+A12, EN 60601-1-11:2015

Delivering leading edge, innovative power solutions for more than **30** years....

Model:GTM96600-65VV-P2(SR with fixed Plug 2 pin)

May 26, 2022

	UKCA Certification
 10276	Ukraine UKRSepro (Document: www.globtek.com/html/iso_certificates/GT_Ukraine.pdf)
	Japan: Voluntary Control Council for Interference (VCCI)
	WEEE: Complies with EU 2012/19/EU (http://ec.europa.eu/environment/waste/wEEE/index_en.htm) Mark is on the label or Molded in the case