

Delivering leading edge, innovative power solutions for more than 30 years....

Model:GTM46101-WWVV-X.X-USB

May 26, 2022

60601-1 Medical DOE EPS 2.0 Level VI Power Supply / Charger, 5v, 2.0A, with integral USB Jack, compliant with 2MOPP, 5000 Meters Elevation and 8 kV Contact/20kV Air Discharge ESD Protection

Information

Model Number

GTM46101-WWVV-X.X-USB

Description

GTM46101-WWVV-X.X-USB, ICT / ITE / Medical Power Supply, 60601-1-4th Ed. , Wall Plug-in, Regulated Switchmode AC-DC Power Supply AC Adaptor, , Input Rating: 100-240V~, 50-60 Hz, Blade Options for Q Series Wall Plug-in Power Supplies, Output Rating: 10 Watts, Power rating with convection cooling (W) , 5-5.5V in 0.1V increments, Approvals: South Africa; EAC; NrCAN (5V only); LPS 62368; NOM (5V only); Conforms to 62368-1; ST-Malaysia; IRAM; ETL 62368; Morocco; Korea (5V-5.4V Only); Taiwan BSMI; South Africa; UKCA; CAN ICES-3; FCC; CE; CB 60601-1 2MOPP; CB 60950; CE; cETLus ES60601; cETLus 60601-1 3rd; China RoHS; Double Insulation; IP20; Level VI; LPS 60950; CB 62368; RoHS; S-Mark IEC/EN 60601-1; Ukraine; cETLus 60950; RCM; CCC; India BIS (5V only); CB EN/IEC 60335-1; PSE;

Model Picture



Agency Documents

<http://www.globtek.info/certs/GTM46101-10VV-X.X/>

CE EC-Declaration

https://www.globtek.com/pdf/ec_declaration/a0Oa000000MEtdeEAD

RoHS/RoHS2 Declaration

https://www.globtek.com/pdf/rohs_cert/a0Oa000000MEtdeEAD

REACH Declaration

https://www.globtek.com/pdf/iso_certificates/REACH.pdf

Conflict Minerals Declaration

<https://www.globtek.com/pdf/conflict-minerals.pdf>

Delivering leading edge, innovative power solutions for more than **30** years....

Model:GTM46101-WWVV-X.X-USB

May 26, 2022

MODEL PARAMETERS

Type	Wall Plug-in
Technology	Regulated Switchmode AC-DC Power Supply AC Adaptor
Category	ICT / ITE / Medical Power Supply
Input Voltage	100-240V~, 50-60 Hz
I/P Amps (A)	0.3A
Wattage (W)	10.0
Vout Range (V)	5-5.5
Efficiency Level	USA DOE Level VI / Eco-design Directive 2009/125/EC, (EU) 2019/1782
Ingress Protection	Indoor Use
Size (mm)	41.0 x 71.0 x 31.5

Delivering leading edge, innovative power solutions for more than 30 years....

Model:GTM46101-WWVV-X.X-USB

May 26, 2022

ENCLOSURE

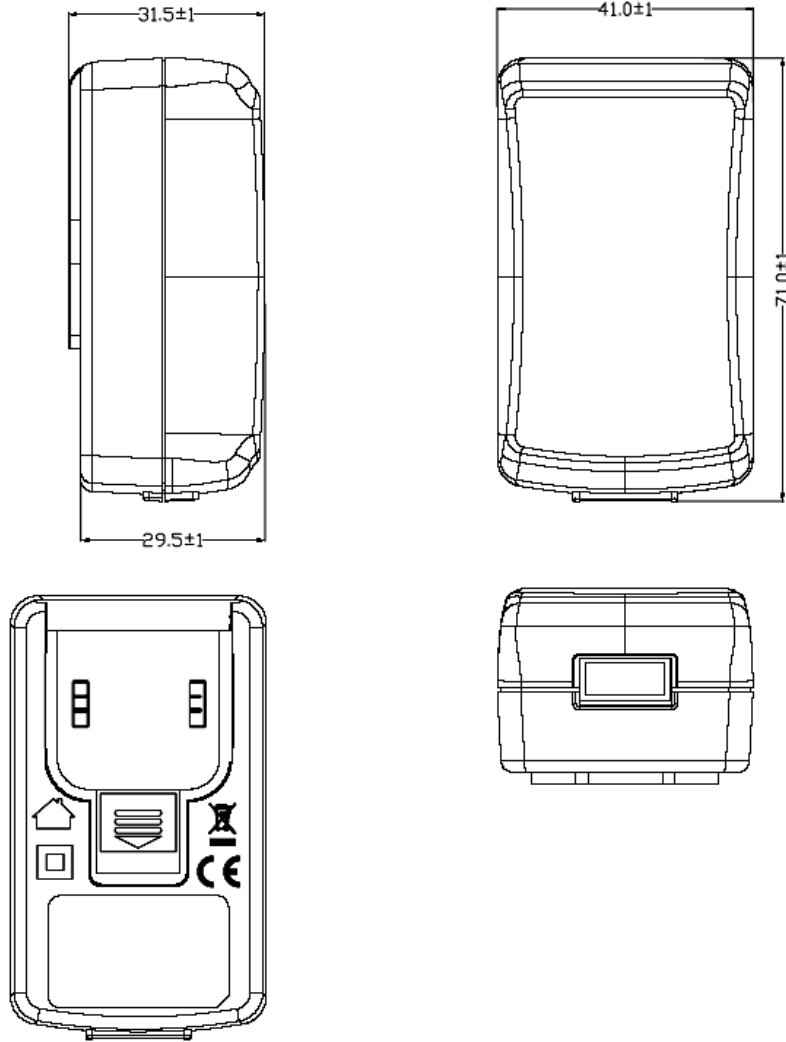

Delivering leading edge, innovative power solutions for more than **30** years....

Model:GTM46101-WWVV-X.X-USB

May 26, 2022

RATING TABLE

Model Number	Voltage	Amps(A)	Watts(W)	RFQ
GTM46101-1005-USB	5 V	2	10.00	RFQ
GTM46101-1306-0.9-USB	5.1 V	2.54	12.95	RFQ
GTM46101-1306-0.8-USB	5.2 V	2.5	13.00	RFQ
GTM46101-1306-0.7-USB	5.2 V	2.45	12.99	RFQ

SPECIFICATIONS

A) ELECTRICAL SPECIFICATIONS:

1. Input Voltage: Specified 90-264 Vac, Nameplate rated 100-240 Vac
2. Input Frequency: Specified 47-63 Hz, Nameplate rated 50-60 Hz
3. Output Regulation: +/- 5% measured at the end of a 1.2 meter USB cordset employing #20 Gauge conductors (RFP RFI-50856)
The longest cable GlobTek recommends to be used with this product is USB cord GlobTek PN USBA1M2MICROB20(R), 1.2 Meters for best voltage regulation performance. (RFP RFI-20435-3)
4. Line Voltage Regulation: +/- 3% typical measured at the end of a 1.2 meter USB cordset employing #20 Gauge conductors
5. Output Ripple (Vp-p): 150mV Ripples shall be measured with a 47uF electrolytic capacitor paralleled with a high-frequency 0.1uF ceramic capacitor across the output. The oscilloscope's bandwidth shall be set to 20MHz.
6. Turn-On/Turn-Off Overshoot: 5% maximum, 500 us maximum recovery time for 25% step load.
7. Turn-On Delay: 3000mS MAX at 115VAC Full Load
8. Hold-Up Time: 8mS Min at 100VAC Full Load
9. Inrush Current: No damage. On power when switching on/off repeatedly under any condition.
10. Switching Frequency: 66.5 KHz typical
11. Average Efficiency: 78.7% Min.(CEC&DOE Level VI Compliant), 79.0% Min. (ErP European Commission's Ecodesign Directive (2005/32/EC) / CoC Tier 2 Compliant)
12. Input Power(no load): < 0.1W < 0.1W, < 0.075W (ErP European Commission's Ecodesign Directive (2005/32/EC) / CoC Tier 2 Compliant)
13. Cable voltage drop compensation circuitry

B) PROTECTION

1. Over-Voltage: Output shut down and auto restart 110% to 140% of Vnom
2. Over Temperature Protection: Output shut down and auto restart
3. Short Circuit Protection Output shut down and auto restart
- 4 Over Load Protection Output shut down and auto restart 110% to 150% of Inom
5. Input Protection: Input line fusing
6. ESD: 8 kV Contact/20kV Air Discharge

C) SAFETY

1. Dielectric Withstand Voltage: 4000Vac or 5656Vdc 10mA 1 minute
2. Earth Leakage Current: N/A for Class II units, there is no PE Ground pin, so earth Leakage current is not measured
3. Touch Current: Maximum allowed values: 100uA NC(Normal condition) 500uA SFC(single fault condition)
4. Means of Protection: 2 x MOPP
5. ROHS 2: Complies with EU 2011/65/EU and China SJ/T 11363-2006

D) EMC

1. Emissions, per EN 55032, EN 61000-6-3, EN 61000-6-4
Conducted Emissions: Class B, FCC Part 15, Class B
Radiated Emissions: Class B, FCC Part 15, Class B
2. Line Frequency Harmonics EN61000-3-2, Class A
3. Voltage Fluctuations/Flicker EN61000-3-3
4. Immunity, per EN 55024, EN 61000-6-1, EN 61000-6-2
Static Discharge Immunity EN61000-4-2, 8kV contact discharge, 15kV air discharge
Radiated RF Immunity EN61000-4-3, 3V/m 80-2700MHz, 80% 1KHz AM.
EFT/Burst Immunity EN61000-4-4, 2KV/100kHz.

PROPRIETARY INFORMATION

PROPRIETARY OF GLOBTEK, INC. ANY REPRODUCTION, DISCLOSURE OR USE OF THIS DRAWING, IN WHOLE OR IN PART, IS HEREBY PROHIBITED EXCEPT AS SPECIFIED IN WRITING BY GLOBTEK, INC.

<https://www.globtek.com/datasheet/w71005>

Delivering leading edge, innovative power solutions for more than **30** years....

Model:GTM46101-WWVV-X.X-USB

May 26, 2022

Line Surge Immunity EN61000-4-5, 1KV differential-mode
Conducted RF Immunity EN61000-4-6, 3Vrms, 80% 1KHz AM
Power Frequency Magnetic Field Immunity EN61000-4-8, NA
Voltage Dip Immunity EN61000-4-11, Criteria B

E) OTHER:

- 1.USB2.0 , USB BC1.2 (DCP) compliant (Certain part numbers only. Check specific datasheet for details)
2. MTBF: 200,000 hours @ 25°C ambient temperature
3. Operating Temperature: 0°C to 40°C ambient temperature
4. Humidity: 0% to 95% relative humidity
5. Storage Temperature: -40°C to 80°C

F) ENCLOSURE

1. Housing: High impact plastic, 94V0 polycarbonate, non-vented
2. Markings: Label and/or Pad Printed and/or Molded in the case

Delivering leading edge, innovative power solutions for more than 30 years....

Model:GTM46101-WWVV-X.X-USB

May 26, 2022

DERATING CURVE

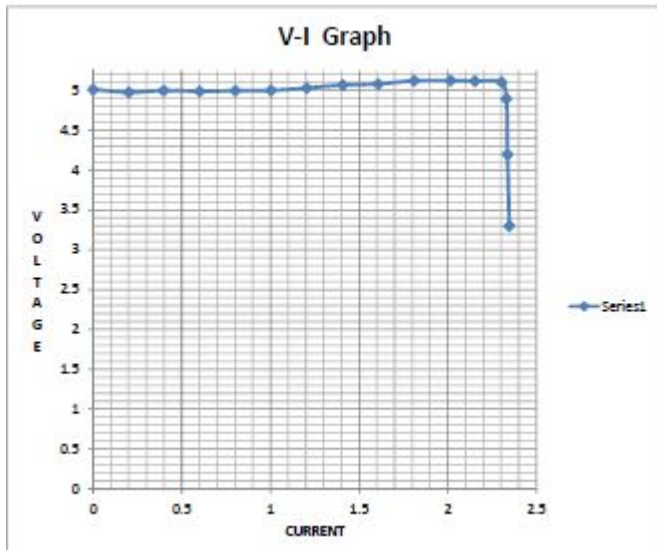
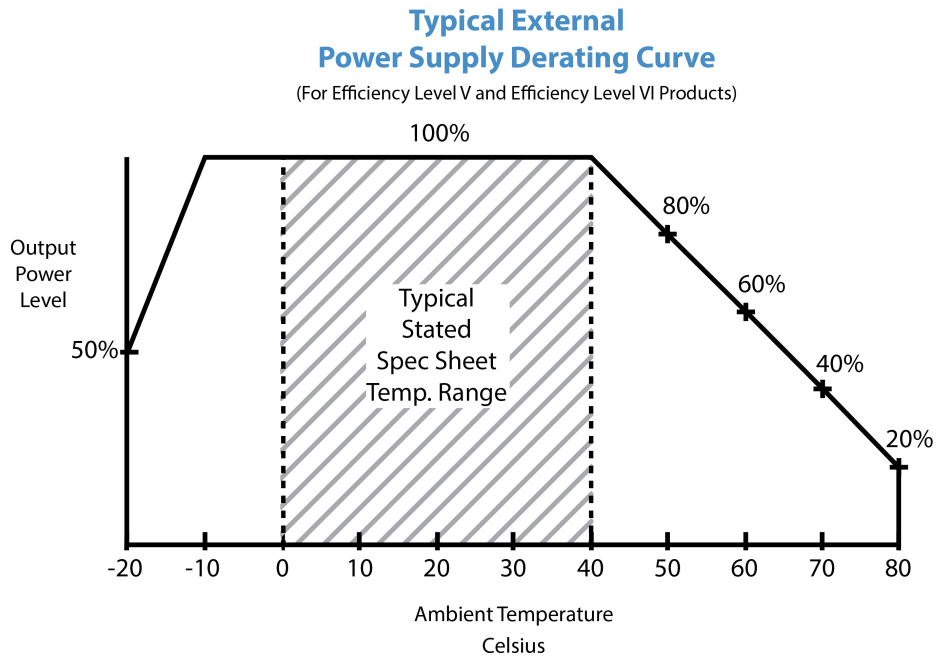

Delivering leading edge, innovative power solutions for more than 30 years....

Model:GTM46101-WWVV-X.X-USB

May 26, 2022

INPUT CONFIGURATION

Description Blade Options for Q Series Wall Plug-in Power Supplies

 Data Sheet: <http://en.globtek.com/interchangeable-blades.php>

 Insertion Instructions: <http://www.globtek.com/pdf/Instructions-Interchangeable-Blades.pdf>

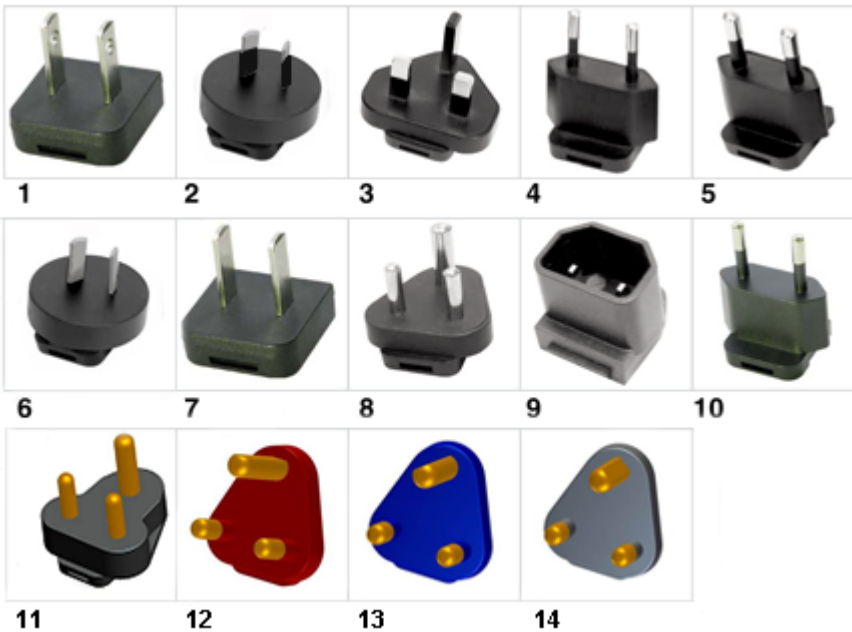
 Video: [Q-Blade Style Instruction Video](#)

INPUT CONNECTOR: Q-Socket (below are available blades configurations which are "not included" (unless stated above); can be purchased separately, package with power supply or as a separate "Q-KIT" if specified

01. United States / Canada / Japan NEMA 1-15P/ IEC PLUG Type A [WORKS IN PLUG B] configuration: NA 2 blades, Class II; US/CA/JP P/N: Q-NA(R)
02. Australian AS 3112 configuration: SAA 2 blade/ IEC TYPE I, Class II; AU P/N: Q-SAA(R)
03. UK BS 1363 configuration: UK 3 blade with dummy Ground/ IEC TYPE G, Class II; GB P/N: Q-UK(R)
04. European CEE 7/16 configuration: Europlug 2 pins/ IEC TYPE C [WORKS IN TYPE E&F], Class II; EU P/N: Q-EU(R)
05. Korean KS C8305 configuration: 2 pins/SIMILAR TO IEC TYPE C, Class II; KR P/N: Q-KR(R)
06. Argentina IRAM 2073 configuration: 2 blades/SIMILAR TO IEC TYPE I; AR P/N: Class II Q-AR(R)
07. China GB 2099 configuration: 2 blades/SIMILAR TO TYPE A, Class II; CN P/N:Q-CN(R)
08. India IS 1293 6A/BS546 configuration: 5A, 3 pins with Dummy Ground, Class II/IEC TYPE D; IN P/N: Q-IN(R)
09. IEC60320/C18 Inlet, Class II; P/N: Q-C18(R)
10. Brazilian NBR6147 configuration: 2 pins, Class II;SIMILAR TO IEC TYPE C BR P/N: Q-BR(R)
11. South Africa SABS164-1 and India IS 1293, IS694, 16A type plug, 3 round prongs, Class II + dummy ground, IEC TYPE M P/N: Q-SANS164-1-16A(R)
12. South Africa SABS164-4, 3 round prongs with a notched prong @ 0°, Class II + dummy ground, IEC TYPE M Red, P/N: Q-SANS164-4L-16A(R)

PROPRIETARY INFORMATION

PROPRIETARY OF GLOBTEK, INC. ANY REPRODUCTION, DISCLOSURE OR USE OF THIS DRAWING, IN WHOLE OR IN PART, IS HEREBY PROHIBITED EXCEPT AS SPECIFIED IN WRITING BY GLOBTEK, INC.

<https://www.globtek.com/datasheet/w71005>

Delivering leading edge, innovative power solutions for more than **30** years....

Model:GTM46101-WWVV-X.X-USB

May 26, 2022

13. South Africa SABS164-4, 3 round prongs with a notched prong @ -53°, Class II + dummy ground, Blue, IEC TYPE M,
P/N:

Q-SANS164-4C-16A(R)

14. South Africa SABS164-4, 3 round prongs with a notched prong @ +53°, Class II + dummy ground, Black,IEC TYPE M

P/N:

Q-SANS164-4R-16A(R)

Kits

01. Q-KIT: 1,2,3,4 above

02. Q-KIT-INTL: 2,3,4 above

03. Q-KIT-6: 1,2,3,4,5,6 above

04. Q-KIT-7: 1,2,3,4,5,6,7 above

05. Q-KIT-8: 1,2,3,4,5,6,7,8 above

Delivering leading edge, innovative power solutions for more than 30 years....

Model:GTM46101-WVVV-X.X-USB

May 26, 2022

OUTPUT CONFIGURATION

Common output connector options:

 L Type (Coaxial
5.5x2.5mm plug)

 C Type (Coaxial
5.5x2.1mm plug)

 K Type (Coaxial
3.5x1.3mm plug)

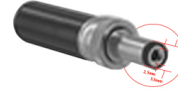
 LL Type (5.5x2.5mm
Locking 760k type)

 CL Type (5.5x2.1mm
Locking S761k type)

 ML2 Type (Molex
housing 43025-0200)

 YL3 Type
(KPPX-3P)

YL4 Type (KPPX-4P)

 EJ1/2/3/4/5 (EIAJ
RC-5320A type
connectors)

 MSB Type (Micro
USB)

 USBC Type (USB
Type C)

 Inquire for custom
design

 For a comprehensive list of options, [click here](#)

Contact GlobTek for your specific requirements or custom solutions.

Delivering leading edge, innovative power solutions for more than 30 years....

Model:GTM46101-WWVV-X.X-USB

May 26, 2022





Approvals

Logo	Description
 R37924 RoHS (Pb)	Taiwan BSMI; http://www.bsmi.gov.tw/wSite/ct?xItem=4072&ctNode=8167=2
No Logo Applicable	CB report IEC60601-1 2005 A1+C1+C2 2016-2-4 and or EN 60601-1:2006 3.1rd Edition 2xMOPP (6W max)
No Logo Applicable	CB for IEC 62368-1:2014 (Second Edition)
No Logo	CB Report IEC60950-1:2005 (2nd Edition), Am 1: 2009 + Am 2:2013
No Logo Applicable	CB to 60335-1 5th Edition (Safety of Household and Similar Electrical Appliances, Part 1: General Requirements) CB Report/ Certificate IEC 60335-1:2010 Up to 36 volts only
 5000	CCC Altitude up to 5000 m GB17625.1-2012, GB4943.1-2011, GB/T9254-2008
	CE Certification CE Mark: tested to comply with EN 55032.2012+AC.2013 EN 61000-3-2.2014 EN 61000-3-3.2013 EN 60601-1-2.2013(Ed4) EN 55024.2010
	CE Mark: tested to comply with EN60601-1-2:2013 (4th Ed), EN61000-3-2, EN61000-3-3, EN50082-1, including EN61000-4-2, EN61000-4-3, EN61000-4-4, EN61000-4-5, EN61000-4-6, EN61000-4-8, EN61000-4-11, EN61000-1-2-2001 EMI: EN55011 CLASS B and FCC Part 15 B
 Intertek 4007407	Audio/Video, Information And Communication Technology Equipment - Part 1: Safety Requirements [UL 62368-1:2014 Ed.2] Audio/Video, Information And Communication Technology Equipment - Part 1: Safety Requirements [CSA C22.2#62368-1:2014 Ed.2]

Delivering leading edge, innovative power solutions for more than 30 years....

Model:GTM46101-WWVV-X.X-USB





May 26, 2022

Conforms to ANSI/AAMI ES 60601-1:2005 Cert.to CAN/CSA Std. C22.2	cETLus ANSI_AAMI ES60601-1_2005
	Medical Electrical Equipment - Part 1: General Requirements For Basic Safety And Essential Performance [AAMI ES60601-1:2005 +A1]Medical Electrical Equipment - Part 1: General Requirements For Basic Safety And Essential Performance [CSA C22.2#60601-1:2014
	Information Technology Equipment Safety Part 1: General Requirements (UL 60950-1 Issued: 2007/03/27 Ed: 2 Rev: 2014/10/14) Information Technology Equipment Safety Part 1: General Requirements (CSA C22.2 No. 60950-1 Issued:2007/03/27 Ed: 2 (R2012) Amd. 1
	CHINA SJ/T 11364-2014, China RoHS Chart: http://en.globtek.com/globtek-rohs.php
Conforms to UL STD. 62368-1 Certified to CSA STD C22.2 NO.62368-1	Conforms to UL STD. 62368-1 Certified to CSA STD C22.2 NO.62368-1
	Declaration ДС № EAЭC N RU Д-US.KA01.B.10453_19 Custom Union of Russia, Belarus and Kazakhstan http://www.globtek.com/redirect/?loc=gost-certificate-eac-declaration
	Compliance of this power supply with FCC Part 15, Class B has been demonstrated with a standard output load. The FCC law stipulates that system-level testing is required to demonstrate compliance with the FCC emission limits with the actual system load.
CAN ICES-3(B)/NMB-3(B)	Compliance of this PSU with Industry Canada, Class B demonstrated with a standard output load. The ICES law stipulates that system-level testing is required to demonstrate compliance with the ICES-3 emission limits with the actual system load.

Delivering leading edge, innovative power solutions for more than **30** years....

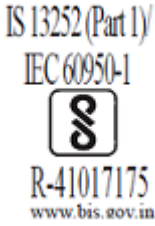
Model:GTM46101-WVVV-X.X-USB





May 26, 2022

	Bureau Of Indian Standards for GTM46101-1005-USB (5V only)
IP20	Ingress Protection: IP20 to IEC60529:2001 Protected against solids objects over 12mm and No Protection
 <p>DC-E-671-006.1 PRECAUCION: PARA USO EN EQUIPOS ELECTRONICOS SOLAMENTE</p>	IRAM certificate DC-E-G71-006.1 to IEC 62368-1:2014
 <p>GlobTek, Inc.</p>	JAPAN TUV R-PSE, Cert. No. JD 50471624, to J62368-1(H30) , J55032(H29),J3000(H25,[15V or less]. Please reference the following website for guidelines on PSE regulations: http://en.globtek.com/importing-ite-and-medical-power-supplies-ac-adaptors-to-japan/
	Korea HU10499-20042A (for GTM46101-USB) 5V-5.4V
EFFICIENCY LEVEL 	Efficiency: complies to section 301 of Energy Independence and Security Act (EISA) complies with Energy Star tier 2 (North America), ECP tier 2 (China), MEPS tier 2 (Australia), Code of Conduct (Europe)
LPS	Limited Power Source 60950
LPS	Limited Power Source 62368

Delivering leading edge, innovative power solutions for more than 30 years....

Model:GTM46101-WVVV-X.X-USB

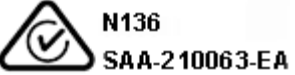
May 26, 2022

	Morocco SDoC declaration http://www.globtek.info/certs/Morocco%20SDoC%20Declaration/
	NOM (Mexico) to NOM-001-SCFI-2018 GTM46101 for 5V only
	Natural Resources Canada (NRCAN): CSA Standard C381.1-08, QSP NRCAN EEV1191; http://shop.csa.ca/en/canada/energy-efficiency/canca-c3811-08/inv/27024802008 (for 5V only)
	RCM certificate SAA-210063-EA Australia and New Zealand Regulatory Compliance, Mark (http://rcm.standards.org.au/rcmfaq/rcmfaq.htm)
RoHS	Specifications of directive 2011/65/EU Annex VI (ROHS-2) with amendment 2015/863-EU (ROHS-3) http://www.ce-mark.com/Rohs%20final.pdf
	Semko S-Mark-Cert-EN60601-1 3.1rd Edition (http://www.intertek.com/marks/s/)
No Logo	SOUTH AFRICAN EMI/EMC SABS for GTM46101-1005-USB
No Logo	South Africa approval NRCS
No Logo	ST-Malaysia GTM46101
	UKCA Certification

Delivering leading edge, innovative power solutions for more than **30** years....

Model:GTM46101-WWVV-X.X-USB

May 26, 2022

 10276	Ukraine UKRSepto (Document: www.globtek.com/html/iso_certificates/GT_Ukraine.pdf)
--	---